

Description

General

The SFP-1000FX13-D10 transceiver from APC is small form factor pluggable module with standard LC duplex connector for fiber communications. This module is designed for single mode fiber and operates at a nominal wavelength of 1310 nm with cost effective and high performance. It is with the SFP 20-pin connector to allow hot plug capability.



Transmitter Section

The transmitter consists of a high-performance 1310 nm Fabry-Perot (FP) laser, which is housed within a metal package. In addition, this component is also class 1 laser compliant with according to International Safety Standard IEC-825

Receiver Section

The receiver contain of an InGaAs PIN photodiode coupled to a high sensitivity transimpedance amplifier (TIA) in an OSA. This OSA combination is mated to a post amplifier IC that provides the post amplification and LOS (Loss of Signal) indication circuit, which provides LVTTTL logic high state output when a unusable input optical signal level is detected.

Features

- Single + 3.3 V power Supply
- Small Form Factor Pluggable MSA Compliant.
- Compliant With IEEE 802.3z Gigabit Ethernet Standard
- PECL Differential Inputs and Output
- TTL Signal Detect Indicator.
- For Single Mode Applications
- LC Duplex Connector
- Class 1 Laser International Safety Standard IEC 825 Compliant
- Temperature Ranges: 0°C to +70°C
- Distance Up to 10 km.
- RoHS Compliant

Applications

- Bridges/Routers/intelligent hub and concentrators
- Gigabit Ethernet / Fiber Channel
- Storage Area Network

Performance Specifications

Absolute Maximum Ratings					
Parameter	Symbol	Min	Typ	Max	Unit
Supply Voltage	V _{CC}	0	-	5	V
Storage Temperature	T _S	-40	-	85	°C
Operating Temperature	T _{OP}	0	-	70	°C
Lead Soldering Limits	T _{SOLD}	-	-	260/10	°C/sec
General Specifications					
Parameter	Symbol	Min	Typ	Max	Units
Data Rate	B	-	1.25	-	Gbps
Supported Link Length on 9/125µm SMF	L	-	10	-	Km

Optical and Electrical Characteristics

Transmitter Electrical Characteristics					
Parameter	Symbol	Min	Typ	Max	Unit
Supply Voltage	V_{CC}	3.15	3.3	3.45	V
Supply Current	I_{CC}	-	-	160	mA
Data Differential Input Voltage	$V_{in, pp}$	300	-	1600	mV
Disable Input Voltage	$V_{IL} - V_{CC}$	-1.81	-	-1.48	V
Enable Input Voltage	$V_{IH} - V_{CC}$	-1.16	-	-0.88	V
Transmitter Optical Characteristics					
Parameter	Symbol	Min	Typ	Max	Unit
Output Optical Power	P_O	-9	-	-2	dBm
Center Wavelength	λ_C	1280	1310	1340	nm
Spectral Width (RMS)	$\Delta\lambda$	-	2	-	nm
Optical Rise Time (10%-90%)	t_r	-	-	0.26	ns
Optical Fall Time (10%-90%)	t_f	-	-	0.26	ns
Extinction Ratio	ER	8.2	-	-	dB

Receiver Electrical Characteristics					
Parameter	Symbol	Min	Typ	Max	Unit
Supply Voltage	V_{CC}	3.15	3.3	3.45	V
Supply Current	I_{CC}	-	-	100	mA
Data Differential Output Voltage	$V_{out, pp}$	300	-	1000	mV
Data Output Rise Time (10%-90%)	t_r	-	-	0.35	ns
Data Output Fall Time (10%-90%)	t_f	-	-	0.35	ns
Receiver Optical Characteristics					
Parameter	Symbol	Min	Typ	Max	Unit
Maximum Receiver Power	P_{in}	-3	-	-	dBm
Receiver Sensitivity	P_S	-	-20	-	dBm
Optical Center Wavelength	λ_C	1100	-	1600	nm
Signal Detect-Asserted	P_A	-	-	-20	dBm avg.
Signal Detect-Deasserted	P_D	-36	-	-	dBm avg.
Signal Detect-Hysteresis	$P_A - P_D$	0.5	-	-	dB

Ordering Information

SFP – 1000FX13 – D10

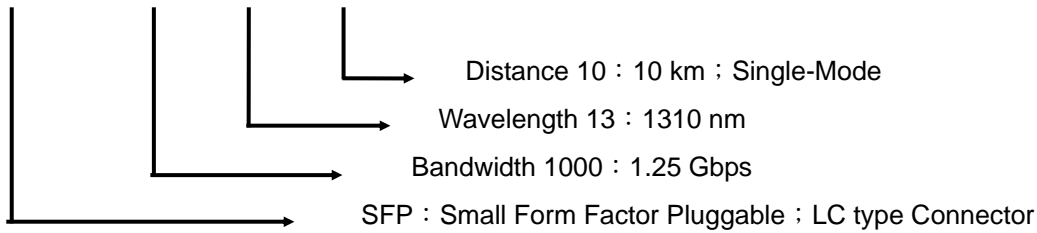

Recommended Circuit Schematic

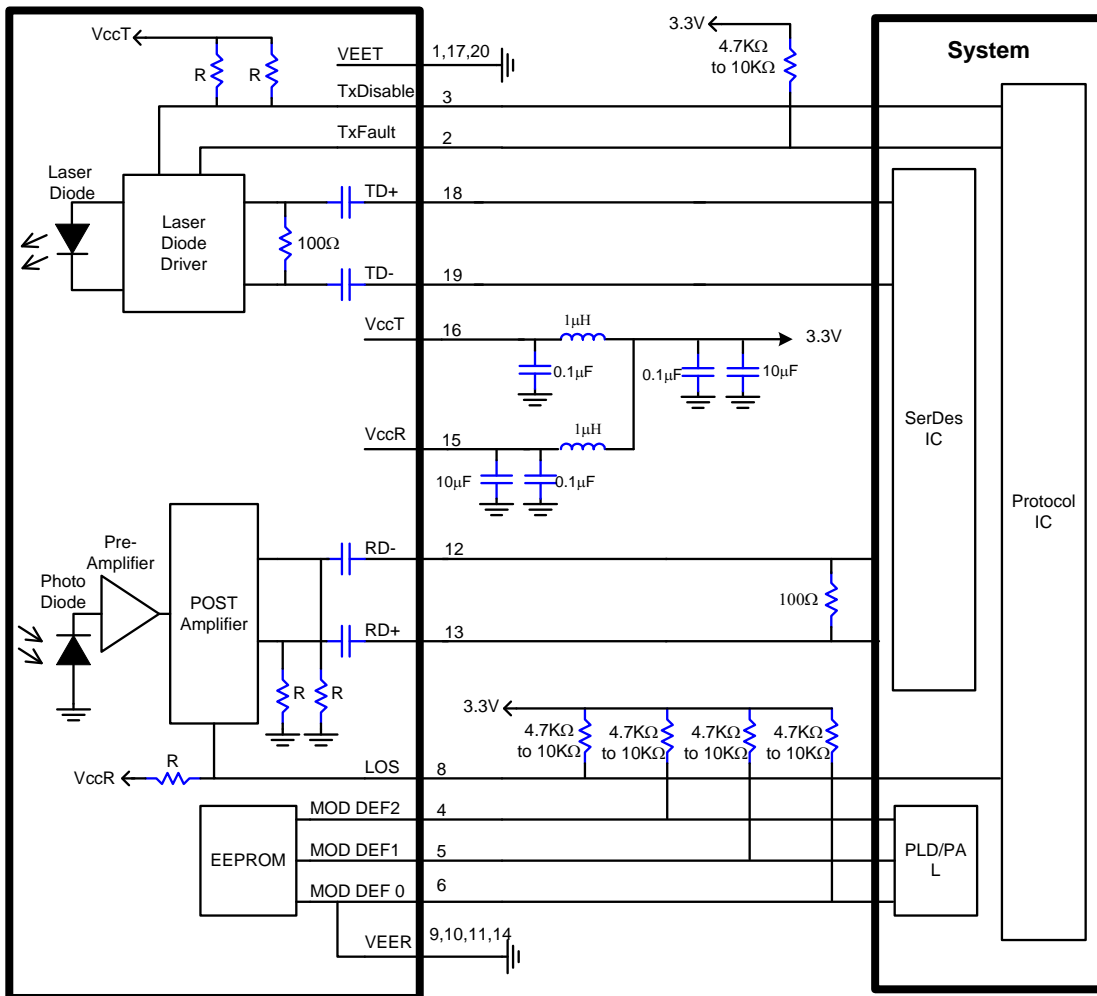

SFP Transceiver Electrical Pad Layout

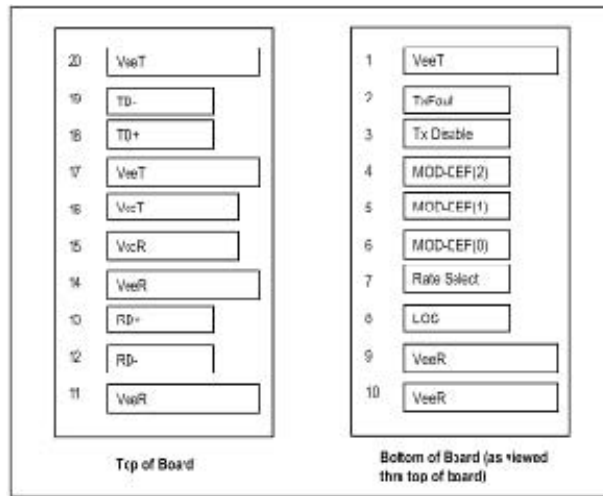

Pinout Table

Pin	Symbol	Name/Description	Ref.
1	V_{EET}	Transmitter Ground	1
2	T_{FAULT}	Transmitter Fault.	4
3	T_{DIS}	Transmitter Disable. Laser output disabled on high or open.	2
4	MOD_DEF (2)	Module Definition 2. Data line for Serial ID.	3
5	MOD_DEF (1)	Module Definition 1. Clock line for Serial ID.	3
6	MOD_DEF (0)	Module Definition 0. Grounded within the module.	3
7	Rate Select	No connection required	
8	LOS	Loss of Signal indication. Logic 0 indicates normal operation.	5
9	V_{EER}	Receiver Ground	1
10	V_{EER}	Receiver Ground	1
11	V_{EER}	Receiver Ground	1
12	RD-	Receiver Inverted DATA out. AC Coupled	
13	RD+	Receiver Non-inverted DATA out. AC Coupled	
14	V_{EER}	Receiver Ground	1
15	V_{CCR}	Receiver Power Supply	
16	V_{CCT}	Transmitter Power Supply	
17	V_{EET}	Transmitter Ground	1
18	TD+	Transmitter Non-Inverted DATA in. 100 ohm termination between TD+ and TD-, AC Coupled thereafter.	
19	TD-	Transmitter Inverted DATA in. See TD+	
20	V_{EET}	Transmitter Ground	1

Notes:

- Laser output disabled on $TDIS > 2.0V$ or open, enabled on $TDIS < 0.8V$.
- Should be pulled up with 4.7k – 10kohms on host board to a voltage between 2.0V and 5.5V. MOD_DEF (0) pulls line low to indicate module is plugged in.
- TX-Fault is open collector output. Should be pulled up with 4.7k – 10k ohms on host board to a voltage between 2.0V and 5.5V.
- LOS is open collector output. Should be pulled up with 4.7k – 10k ohms on host board to a voltage between 2.0V and 5.5V. Logic 0 indicates normal operation; logic 1 indicates loss of signal.

Package Outline Drawing

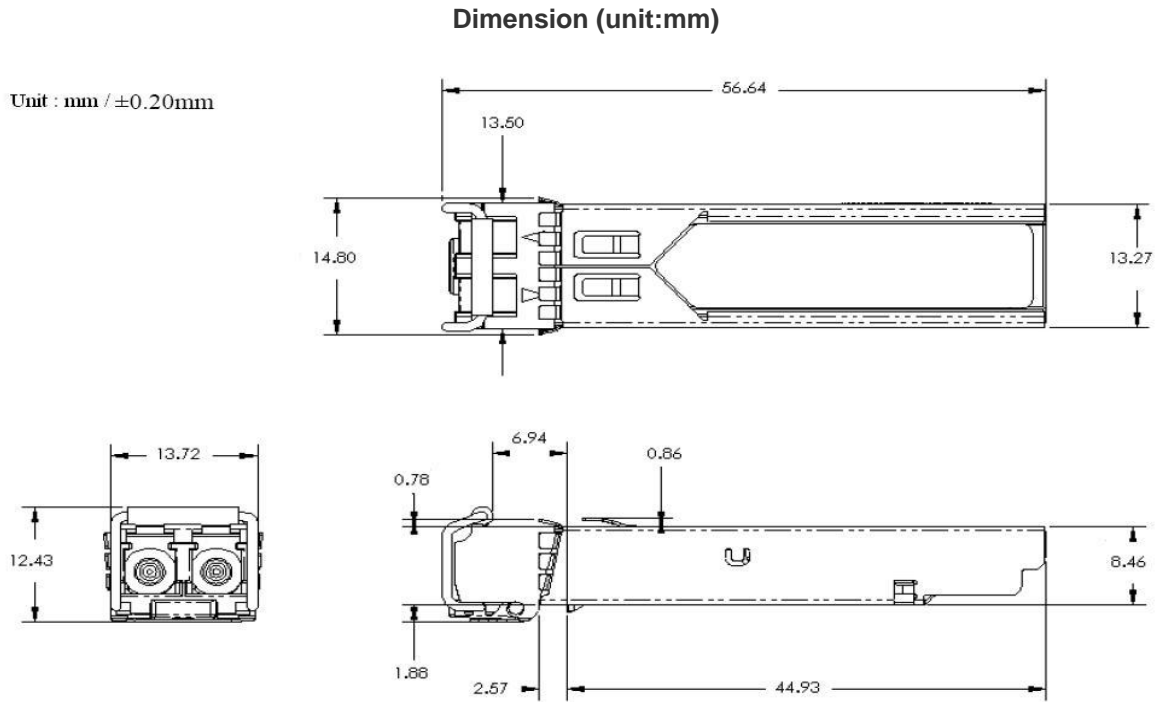

RoHS Reference

Material Classify	Substance	Reference	Standard	Analysis	Equipment
Heavy Metals	Lead (Pb)/ Lead Compounds	2002/95/EC	< 1000 ppm	US EPA 3050B	ICP-AES
	Cadmium (Cd)/ Cadmium Compounds	2002/95/EC	< 100 ppm	EN1122-2001 91/338/EEC	ICP-AES
	Mercury (Hg) / Mercury Compounds	2002/95/EC	< 1000 ppm	US EPA 3052	ICP-AES
	Hexavalent-Chromium(Cr6+)Compounds	2002/95/EC	< 1000 ppm	US EPA 3060A & 7196A	UV-VIS
Brominated Organic Compounds	PolyBrominated Biphenyls (PBB)	2002/95/EC	< 1000 ppm	US EPA 3540 & 3550	GC/MS
	PolyBromo Diphenyl Ethers(PBDE)	2002/95/EC	< 1000 ppm	US EPA 3540 & 3550	GC/MS

Qualification Information

Heading	Test	Conditions	Sample Size	Reference
Mechanical & Physical	Mechanical Shock	5 times/axis 500G , 1.0ms	11	MIL-STD-883 Method 2002
	Vibration	20G , 20Hz - 2000HZ 4min/cycle ,4cycles/axis	11	MIL-STD-883 Method 2007
	Thermal Shock	Delta T=100°C	11	MIL-STD-883 Method 2003
	Solderability	-	11	MIL-STD-883 Method 2007
	Fiber Pull	1Kg ; 3times ; 5sec	11	Bellcore 983
Endurance	Accelerated Aging	85°C , 5000hrs	25	Bellcore 983 Section 5.18
	High Temperature Storage	85°C , 2000hrs	11	Bellcore 983
	Low Temperature Storage	-40°C , 2000hrs	11	Bellcore 983
	Temperature Cycling	500 cycles.	11	Bellcore 983 Section 5.20
	Cyclic Moisture Resistance	10 cycles	11	Bellcore 983 Section 5.23
	Damp Heat	40°C , 95% RH , 1344hrs	11	MIL-STD-202 Method 103
Special Test	Internal Moisture	<5000ppm water vapor	11	MIL-STD-883 Method 1018
	Flammability	-	-	TR357 Sec.4.4.2.5
	ESD Threshold	-	6	Bellcore 983 Section 5.22